

# CENTRAL SUCTION SYSTEMS

**Dry / semi-wet suction**

**For 1 - 15 dental units**

**Underpressure of 180 mbar**



 **METASYS**

# METASYS suction systems

## Efficient solutions for every dental office

The METASYS „EXCOM hybrid/VAC“ range has become synonymous with powerful vacuum technology in the dental field. A constantly high vacuum in the METASYS suction systems provides the best possible means for guaranteeing that the patient is treated safely. Without continuous vacuum, fluid collects in the patient's mouth and this impairs treatment. Furthermore, rotating instruments can cause particulate material to accumulate as aerosols, which in turn brings a risk of infection.

### Regardless of whether you require dry or semi-wet suction – EXCOM hybrid masters it all

EXCOM hybrid combines dry and semi-wet suction technology in a single device. Regardless of the conditions and regardless of whether it's a semi-wet or dry suction system, the same device can be used for both systems. This provides the dentist and the office planner with a high degree of planning flexibility, as two different suction systems (dry/semi-wet) can be combined or they can be changed over time. This makes stock-keeping, servicing and above all technical service equipment easier for the dental dealers, as the same device can always be used.

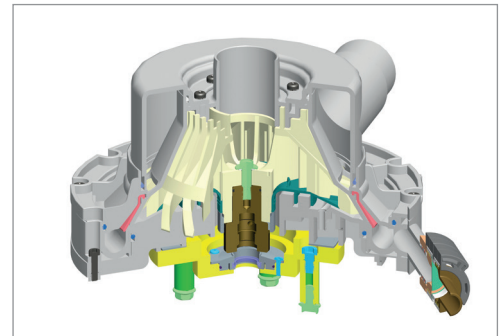

### EXCOM hybrid: Suction for up to 15 and more dental units

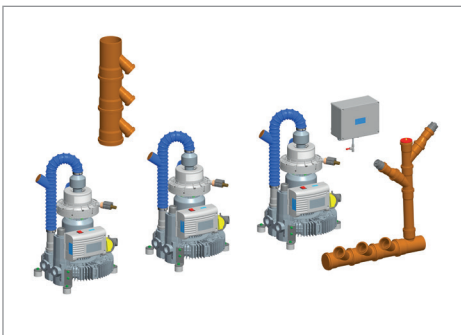

METASYS suction systems can be used to find the perfect solution according to the requirements of a dental office. Solutions for up to 15 dental units are possible without a loss of suction or restrictions to patient treatment; the potential savings are therefore huge. It is therefore important to calculate the suction requirements correctly in the planning phase.

Our calculation table makes it a breeze to calculate air quantities and suction values exactly based on the number of units, as well as the size, number and diameter of suction lines, and furthermore to make the right choice of suction system as a result. You can download the calculation table and additional tips for correct calculation from [www.metasys.com/download](http://www.metasys.com/download).

### EXCOM hybrid + ECO II: Semi-wet suction with amalgam separation on sedimentation base

A central, ISO-certified amalgam separation module can be added to each METASYS EXCOM hybrid suction system; it therefore meets the legal constraints for amalgam separation.

ECO II and ECO II Tandem amalgam separators are impressive due to functioning without maintenance, without any electrical switching and monitoring equipment, being quick and easy to install and their unbeatable price advantage.

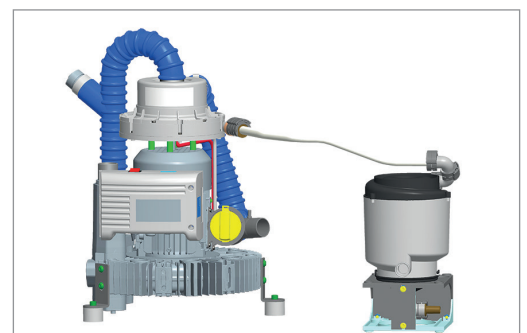

# METASYS suction systems

## Overview

### Semi-wet suction

#### WITHOUT AMALGAM SEPARATION

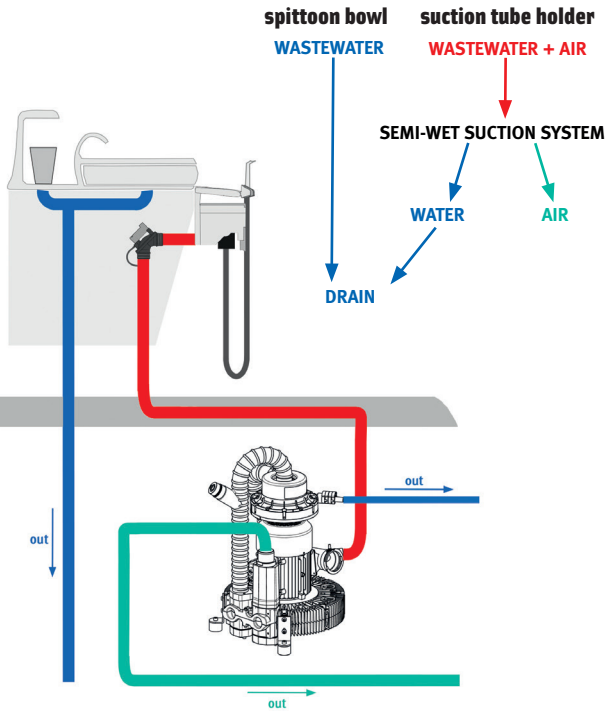

#### WITH AMALGAM SEPARATION

(for example, with METASYS ECO II)

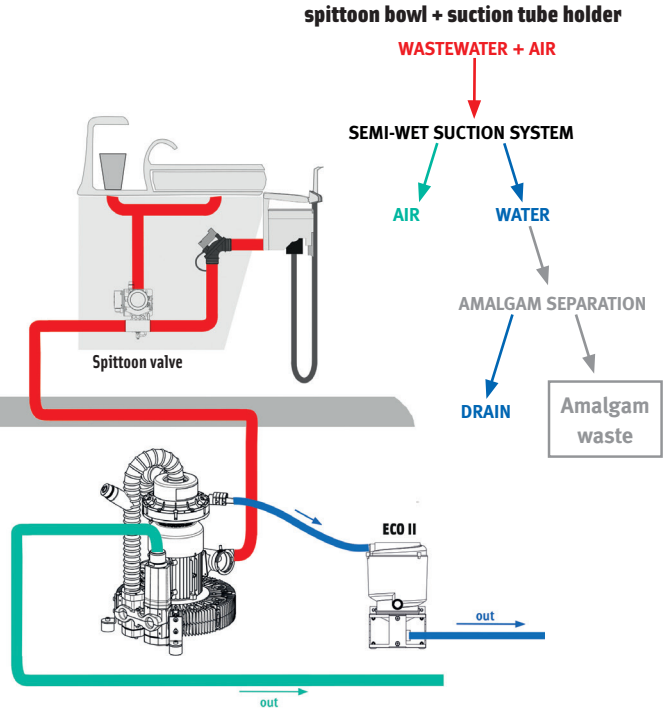

### Dry suction

#### ONLY AIR/WATER SEPARATION

(for example, with METASYS MST1 ECO Light)

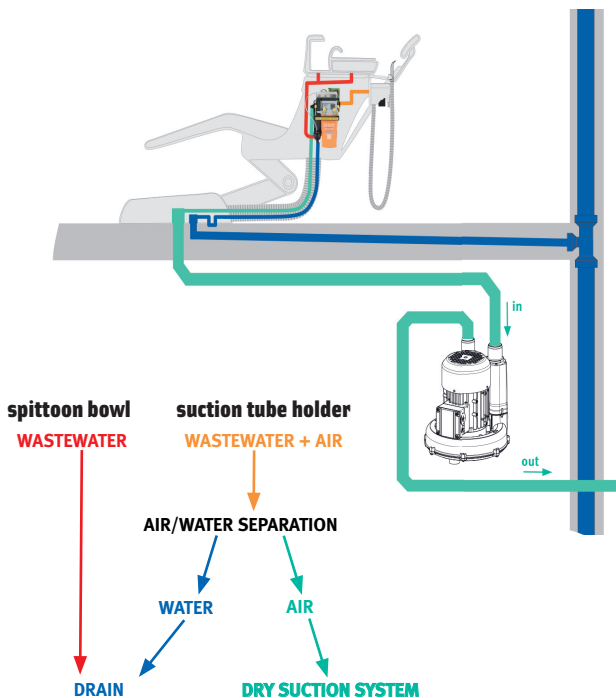

#### AIR/WATER SEPARATION & AMALGAM SEPARATION

(for example, with METASYS MST1)

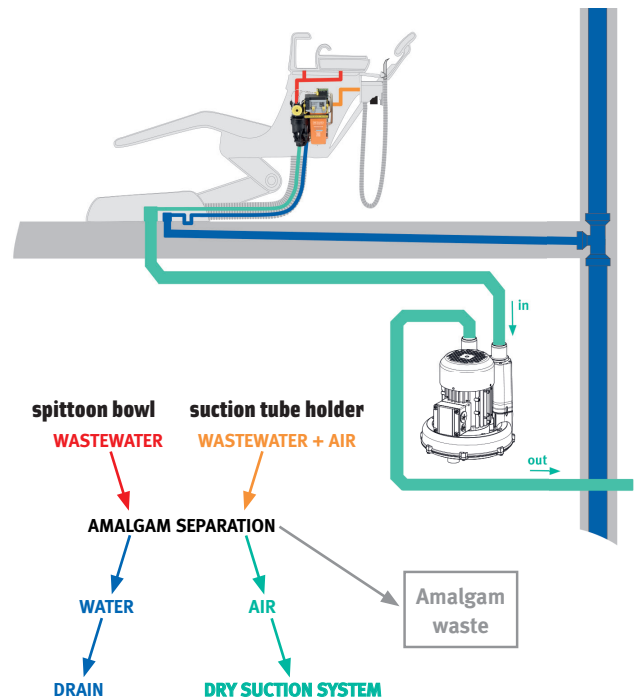

# Single-unit suction systems

Highest quality in all details

## Centrifugal separation rotor

Separation module that guarantees constant, flawless separation through centrifugal force, even with higher foam loads. Long-term functionality of a suction pump over many years is only guaranteed with reliable separation.

## Frequency-controlled suction power regulation\*

Suction power regulation is provided by a frequency controller, which ensures a constantly high vacuum of 180 mbar at the suction tubes, depending on the performance requirement. Furthermore, the frequency-controlled function provides a significant reduction in the energy consumption.

\* only with EXCOM hybrid 5

## Aluminium turbine wheel

A free-running aluminium turbine wheel guarantees long-term operational reliability. Plastic wheels are not used.

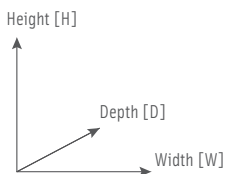
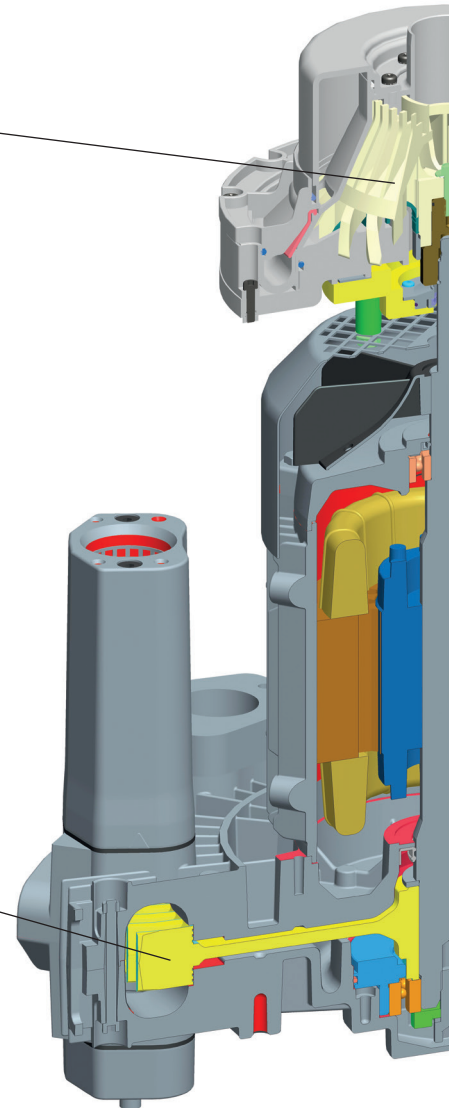

	EXCOM hybrid 1s	EXCOM hybrid 1	EXCOM hybrid A1
Item no.	02010153*	02010311	02010251
Power supply	230 V AC	230 V AC	230 V AC
Frequency	50 / 60 Hz	50 / 60 Hz	50 / 60 Hz
Max. current consumption	3,5 / 4,5 A	7,6 A	7,6 A
Max. electrical shaft power	0,55 / 0,63 kW	0,94 / 1,1 kW	0,94 / 1,1 kW
Max. ambient temperature	40 °C	40 °C	40 °C
Air flow rate	1100 l/min	1100 / 1300 l/min	1100 / 1300 l/min
Negative pressure regulated	120 / 140 mbar	180 mbar	180 mbar
Noise level	63 dB(A)	57 / 62 dB(A)	57 / 62 dB(A)
Dimensions (H x W x D) mm	530 x 350 x 320	570 x 422 x 400	570 x 770 x 400
Weight	15 kg	22 kg	24,5 kg
Operating time	100 %	100 %	100 %
Separation rate	-	-	99,3 %

\*also available with control box

# Central suction systems

The highest level of technology

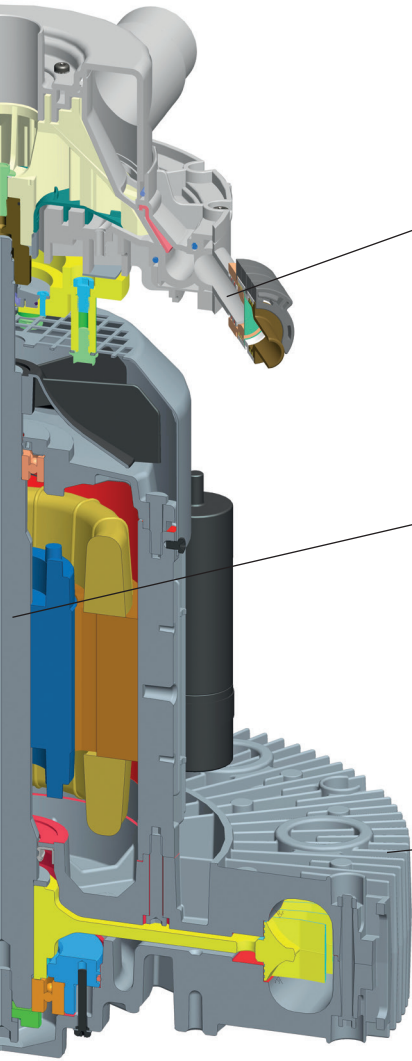

## High wastewater outlet

A wastewater outlet that is installed at this height enables convenient connection to the drain or amalgam separator.

Further installation work due to a requirement for any elevation of the suction device is therefore not required.

## One motor shaft

One motor shaft moves both the vacuum generator and separation and ensures that they can both function at the same time. The danger of a possible fluid overflow due to non-functioning separation in a working suction pump is therefore avoided.

## Airflow-optimised cooling fins

The special design of the optimised air cooling fins results in improved cooling and greater protection against overheating. Efficient cooling airflows at these cooling fins enable faster heat reduction.



### EXCOM hybrid 2

02010312

230 V AC

50 / 60 Hz

7,6 A

1,1 / 1,3 kW

40 °C

1450 / 1750 l/min

180 mbar

58 / 63 dB(A)

580 x 450 x 400

27 kg

100 %

-

### EXCOM hybrid A2

02010221

230 V AC

50 / 60 Hz

7,6 A

1,1 / 1,3 kW

40 °C

1450 / 1750 l/min

180 mbar

58 / 63 dB(A)

580 x 780 x 400

29,5 kg

100 %

99,3%

### EXCOM hybrid 5

02010313 | 02010314

230 V AC | 400 V AC

50 / 60 Hz

9,0 / 10,0 A | 4,3 / 4,4 A

1,5 / 1,75 kW

40 °C

2000 / 2400 l/min

180 mbar

64 / 68 dB(A)

620 x 460 x 455

30 kg

100 %

-

### EXCOM hybrid A5

02010222 | 02010224

230 V AC | 400 V AC

50 / 60 Hz

9,0 / 10,0 A | 4,3 / 4,4 A

1,5 / 1,75 kW

40 °C

2000 / 2400 l/min

180 mbar

64 / 68 dB(A)

620 x 915 x 455

35 kg

100 %

99,3%

# METASYS solutions

## METASYS VAC 1s

### Cost-effective

Great value for money

### Efficient

Excellent suction power of up to 140 mbar (60 Hz)

### Quiet

Quiet operation at only 53 dB(A)



	VAC 1s
Item no.	04010013*
Power supply	230 V AC
Frequency	50 / 60 Hz
Max. current consumption	3,5 / 4,5 A
Max. electrical shaft power	0,55 / 0,63 kW
Max. ambient temperature	40 °C
Air flow rate	1000 l/min
Negative pressure regulated	120 / 140 mbar
Noise level	53 / 56 dB(A)
Dimensions (H x W x D) mm	280 x 244 x 245
Weight	11 kg
Operating time	100 %
Separation rate	-

\*also available with control box



### The perfect addition

In combination with the METASYS MST 1 ECO Light, the VAC 1s is the perfect solution for dry suction with air/water separation.

### METASYS MST 1 ECO Light

Item no. 01010033

## The right care makes the difference!

Cleaning and disinfecting the entire system properly is essential for both hygiene and functional reasons. The reduction in dirt and biofilm prevents performance reductions and increases the service life of the devices\*.

GREEN&CLEAN M2: Dual, active defoaming concentrate to disinfect and deodorise suction systems and amalgam separators.



\*Please observe the usage instructions!

### WITH GREEN&CLEAN M2

Residues-free  
module 2 works  
flawlessly



No biofilm thanks to  
correct cleaning and  
disinfection



No traces of biofilm  
in the suction  
system's hose



### WITHOUT GREEN&CLEAN M2

Deposits on  
module 2 in  
the MST1



Biofilm on water  
deflector in  
the MST1



Biofilm in the  
suction system's  
hose

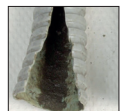

# The complete solution

## META Tower

### All of the META Tower's components are impressive:

Compressed air, suction power and amalgam separation combined completely in one device.

- > Powerful thanks to first-class METASYS quality
- > Pace-saving for positioning in tiny spaces (0.36 m<sup>2</sup> space required)
- > Quiet operation at only **54 dB(A)**

**METASYS**

### Compressed air

META Air compressors with the latest membrane drying technology supply hygienic compressed air.

### Suction

EXCOM hybrid central suction systems provide an underpressure of 180 mbar.

### Amalgam separation

Central, maintenance-free amalgam separation technology based on sedimentation with complete recycling concept.



	<b>META Tower 2</b>	<b>META Tower 5</b>	<b>META Tower A2</b>	<b>META Tower A5</b>
Item no.	07010001	07010002	07010011	07010012
Units	up to 3 units	up to 5 units	up to 3 units	up to 5 units
Amalgam separator	without	without	with ECO II D	with ECO II Tandem D

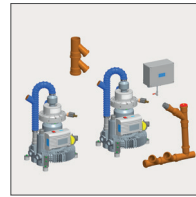

### Parallel connection for 2 or 3 EXCOM hybrid devices

Item no. 40040012 (for 2), item no. 40040013 (for 3)

Automatic controller for 2 or 3 EXCOM hybrid devices arranged in parallel for powerful suction for up to 15 dental units. Vacuum sensors are used to activate the individual devices as required. This guarantees cost-effective and continuously even operation.



### METASYS covers

Different covers to minimise noise can be ordered for the relevant EXCOM hybrid versions.



### Place selection valve

Item no. 40050048

The METASYS place selection valve is installed in the suction line to open the suction flow for a dental unit in central suction systems.



### Spittoon valve

Item no. 40050002

The spittoon valve is used to connect the spittoon bowl with the suction line in semi-wet suction systems. It can be easily installed in the dental unit thanks to its small dimensions and flexible connections. Capacitive sensors are used to control the valve.

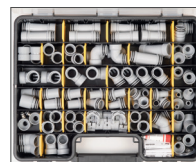

### META Connect fittings case

Item no. 40400008

The META Connect fittings case is a complete installation set with more than 125 fittings and accessories. All connections can be re-ordered individually.



### Pipe silencer

Item no. 40060007

We recommend installing a METASYS pipe silencer to reduce noise emissions in the exhaust.

## METASYS – your strong partner



### METASYS Medizintechnik GmbH

Florianstraße 3, 6063 Rum bei Innsbruck, Austria

☎ +43 512 205420 | 📠 +43 512 205420 7

[www.metasys.com](http://www.metasys.com) | [info@metasys.com](mailto:info@metasys.com)



#### GERMANY

+49 8823 938 44 33

[info@metasys.com](mailto:info@metasys.com)

#### FRANCE

+33 4 37 90 22 15

[info@metasys.fr](mailto:info@metasys.fr)

#### ITALY

+39 045 981 4477

[desitalia@metasys.com](mailto:desitalia@metasys.com)

- Amalgam separation
- Hygienic compressed air
- Suction
- Water decontamination
- Infection control
- Recycling